

Features

- Low-threshold design for easy entry and exit.
- Recessed rear drain.
- Single threshold for three-wall installation.
- Requires K-9333 Groove aluminum drain cover or K-9337 Groove teak drain cover (sold separately).

Material

- Acrylic.

Required Products/Accessories

K-9333 Drain Cover

or

K-9337 Drain Cover

Recommended Products/Accessories

K-9132 Shower Drain

K-23726 Drain treatment

K-23732 Tub & shower cleaner



Codes/Standards

CSA B45.5/IAPMO Z124

ASTM E162







ASTM E662

KOHLER® Plastic Baths and Receptors Lifetime Limited Warranty

See website for detailed warranty information.

Available Colors/Finishes

Color tiles intended for reference only.

Color	Code	Description
	0	White
	96	Biscuit
	47	Almond
	NY	Dune
	95	Ice™ Grey
	G9	Sandbar

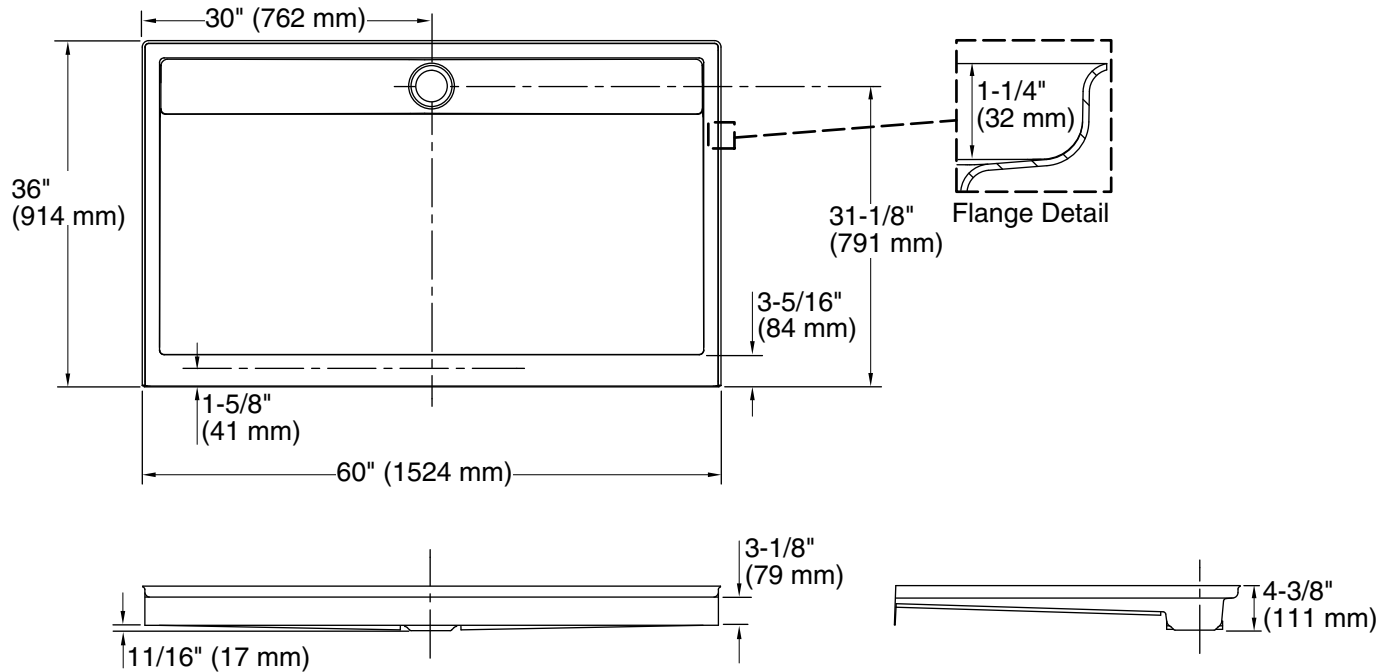

Technical Information

All product dimensions are nominal.

Installation:	Three-wall alcove
Drain location:	Center rear
Weight:	63 lbs (28.6 kg)
Minimum floor load:	20 lbs/ft ² (97.6 kg/m ²)

Notes

- Measure your actual product for rough-in details.
- Install this product according to the installation instructions.
- Shimming may be required to level the fixture.
- Shimming may be required between the stud frame and the fixture.
- Stud opening tolerance is + 1/4" (6 mm), - 0" (0 mm).